

REVISIONS				
ZONE	REV	DESCRIPTION	DATE	APPROVED
	0	RELEASED FOR PRODUCTION	5/15/2000	Lou Nielsen

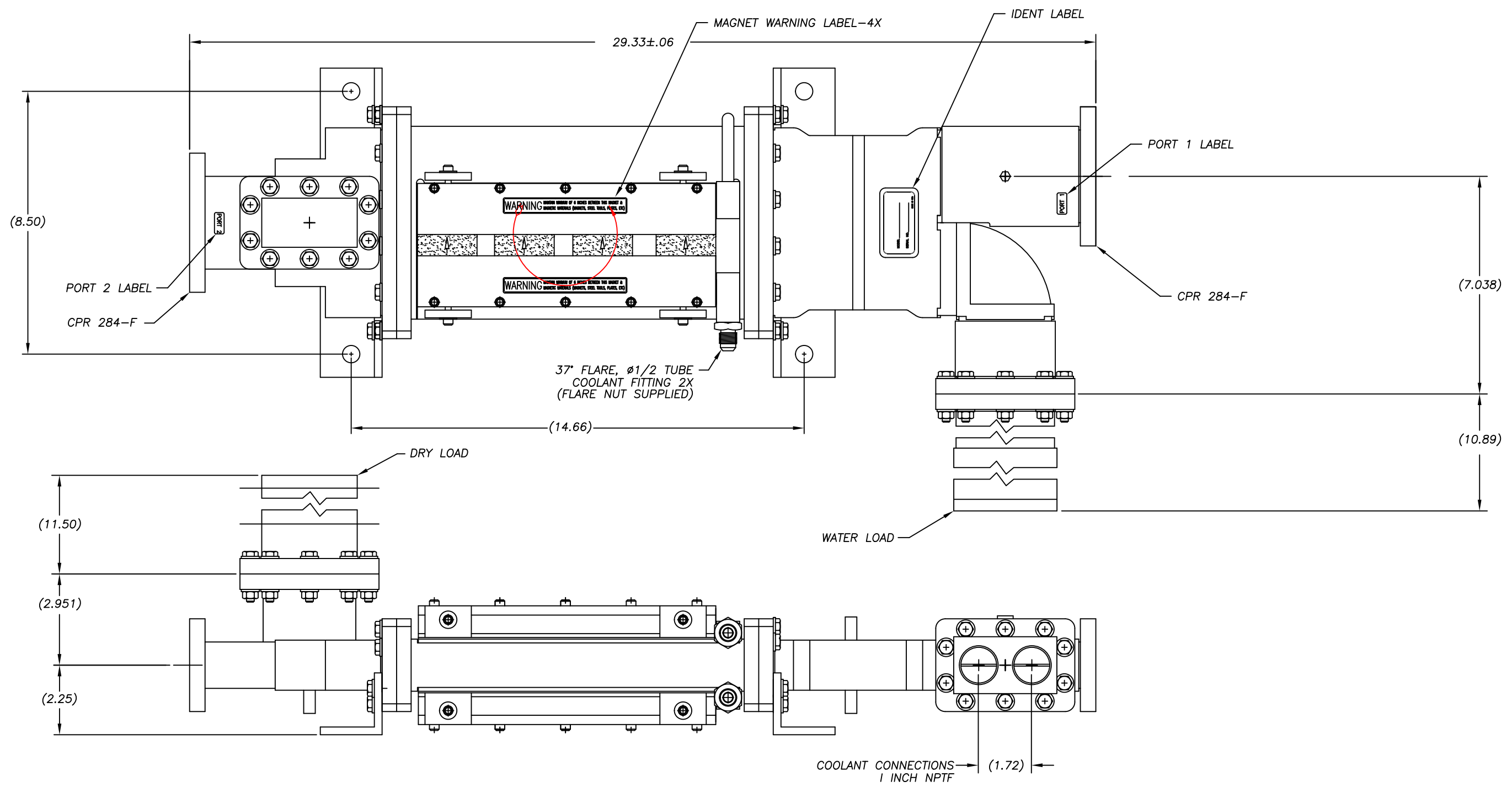

TOLERANCES
(UNLESS OTHERWISE SPECIFIED)

DECIMALS: 1 PLACE +/- .050
2 PLACE +/- .020
3 PLACE +/- .005

FRACTIONS: +/- 1/16
ANGLES: +/- 1/2 DEGREE

FINISH: 63 U INCH OR BETTER
EDGES: BREAK EDGES 1/32 R MAX.

MATERIAL: REFERENCE

CML Engineering, Inc.
2020 Ridgecrest Place, Escondido, CA 92029 TEL: 760-432-8490 FAX: 760-432-8350

OUTLINE, MODEL 2320-02

SIZE B	CAGE CODE 1ZLK8	DWG NO. 2320-02-0000	REV 0
SCALE NONE	Drawn By: L/JN	Date: 5/12/2000	SHEET 1 of 1